

LED TAPE LIGHT CHANNEL

WARNING



NEVER PLUG IN LOW VOLTAGE TAPE LIGHT INTO LINE VOLTAGE

REMOVE TAPELIGHT FROM SPOOL BEFORE INSTALLATION

PRODUCT SHOULD BE INSTALLED BY A LICENSED ELECTRICIAN

Safety and Warnings

- National and local electrical code regulations should be kept in mind while installing the tape light.
- A qualified licensed electrician is intended to install this product.
- A compatible Class 2 power supply must be used for this product.
- Avoid installing in direct sunlight, as LED chips could be damaged.
- Do not power the tape light while coiled in the plastic spool, excessive heat can damage LEDs.
- Make sure the product isn't surrounded by anything conductive or not rated for high temperatures.
- Different tape lights have different voltage ratings, make sure wire length and driver are compatible.
- Handle tape light with care, excessive bending and force can damage it.
- Not all tape lights are rated for outdoor/wet location use, check our website for specifications.

LED Tape Light Handling Instructions



Can bend backwards

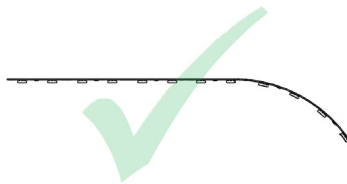

Can bend forwards

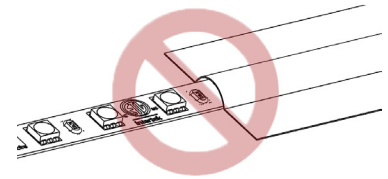

Do not cover tape light with anything

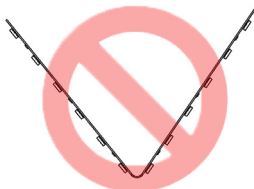

Do not fold or crease

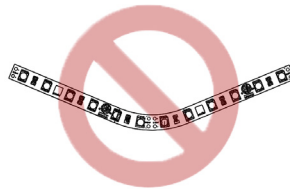

Do not bend vertically up or down

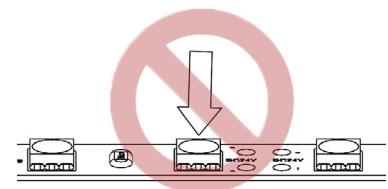

Do not apply force on LEDs

LED TAPE LIGHT CHANNEL

Before installation, make sure all electrical components and PreciseLED products are compatible with each other.

1. Measure and cut channel, lens, and tape light.

- a. Consult the “LED Tape Light Drivers” instruction sheet (<http://preciseled.com/wp-content/uploads/Driver-Overview.pdf>) to choose a driver for your tape light. Determine desired length to cut tape light, noting that PreciseLED tape lights must *only* be cut where indicated with images of scissors. **Avoid excessive voltage drop by calculating maximum tape light length using the “LED Tape Light Drivers” document.** Cut using scissors.



- b. Determine desired length to cut metal channel, allowing 1/8" extra on each side of tape light strip to account for end cap. Note that an end cap extends approximately 1/8" beyond the end of the channel. Cut using a saw fit for metal.

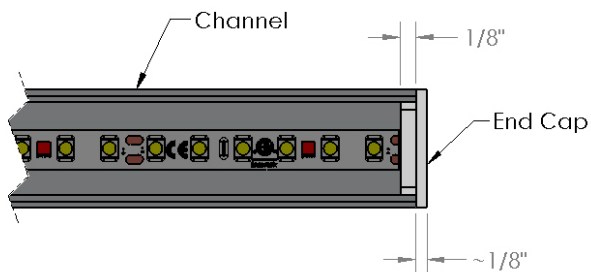

- c. Determine desired length to cut lens, equal to the length of the channel. Cut using a saw.

2. **Install mounting brackets.** Mark holes for mounting brackets on mounting surface. Use at least one mounting bracket for every 3' of channel. Fasten mounting brackets with mounting screws.



3. **Install tape light into channel.** Make sure channel, tape light, lens, and end caps fit properly before permanently joining components. Beginning at one end of the tape light, remove the paper protecting the 3M™ adhesive backing and adhere it to the channel, then continue to the far end of the light strip. **DO NOT press directly on any LED element, as this could damage the lights.** Ensure tape lights lays flat in channel. **The tape light will get hot:** make sure it is not surrounded by anything conductive or not rated for high temperatures.

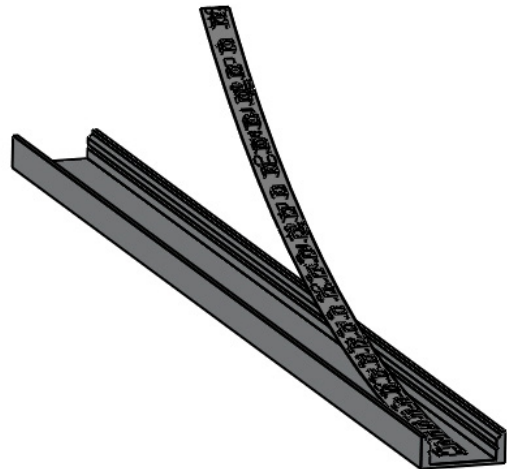

LED TAPE LIGHT CHANNEL

4. Test tape light. Ensure input power is off. Connect all wires to driver, as shown below. Check that connections are secure, and polarity is correct, then turn on power to driver. Ensure that fixture is working properly, then turn off power.

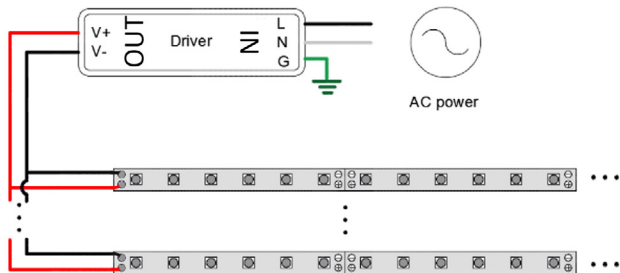

5. Install lens and end caps. Remove wires from driver and feed through end cap with hole, then reconnect wires and insert end cap into channel. Install lens, beginning at one end by first pressing one edge into channel, then the other. Continue down the length of the channel to completely install lens. Insert other end cap into fixture.

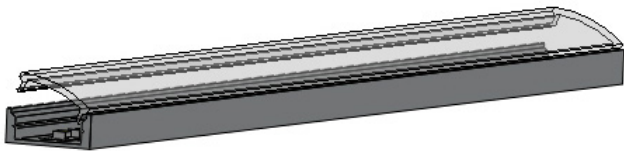

6. Mount fixture. Take completed channel and press into mounting brackets, ensuring that mounting brackets firmly hold channel. Reassure proper operation.

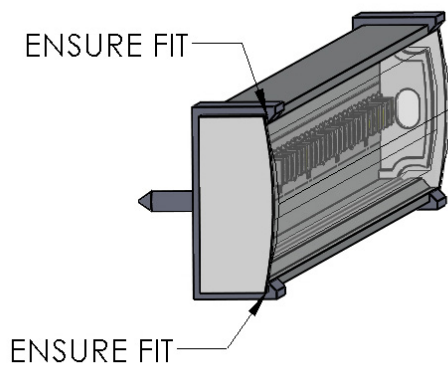

File Name: Figure Flat Channel Installation Guide
Updated: JUL. 18, 2016