

LED 3" Shallow Fixed IC Downlight

DESCRIPTION

Novation® Shallow Fixed Housing utilizes our proprietary water cooling technology to provide up to 30W of power in a small profile.

23 W Output Performance

| Color Temperature | 2700K | | 3000K | | 3500K | | 4000K | |
|---|---------|---------|---------|---------|---------|---------|---------|---------|
| | 90+ CRI | 95+ CRI | 90+ CRI | 95+ CRI | 90+ CRI | 95+ CRI | 90+ CRI | 95+ CRI |
| Source Lumens (lm) | 1900 | 1822 | 2120 | 1852 | 2310 | 1885 | 2450 | -- |
| Delivered Lumens (lm) (60° Beam Spread) | 1456 | 1397 | 1625 | 1420 | 1771 | 1445 | 1878 | -- |
| Delivered Lumens (lm) (45° Beam Spread) | 1328 | 1274 | 1482 | 1295 | 1615 | 1318 | 1713 | -- |
| Delivered Lumens (lm) (38° Beam Spread) | 1349 | 1293 | 1505 | 1315 | 1640 | 1338 | 1739 | -- |
| Delivered Lumens (lm) (24° Beam Spread) | 1274 | 1221 | 1421 | 1241 | 1548 | 1264 | 1642 | -- |
| Delivered Lumens (lm) (12° Beam Spread) | 1286 | 1233 | 1435 | 1254 | 1563 | 1276 | 1658 | -- |

For wattage options other than 23W please use the multiplier chart to calculate the output performance

| Wattage | 30 | 23W | 14W | 10W |
|------------|-----|-----|------|------|
| Multiplier | 1.3 | 1 | 0.61 | 0.43 |

Project Name:

Fixture Type:



DIMENSIONS

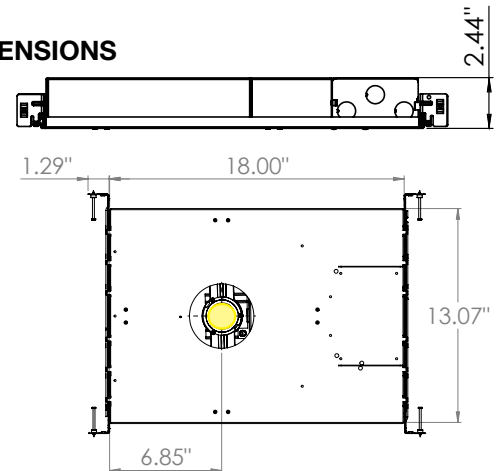

ORDERING CODE

Example: **NVTN-3-SH-23W-30K-3G-60D-ST3-AT-CL-MI-HBAR-COLR**

| Product | Watts | Color Temperature | Chip Type | CRI | Version | Beam Spread Lens | Driver | Housing |
|------------------|---|---|---|---|-------------------|--|---|---|
| NVTN-3-SH | | | | | 3G | | | |
| NVTN-3-SH | 10W 10 Watts 14W 14 Watts 23W 23 Watts 30W 30 Watts Custom Wattage (Max 30W) | 27K 2700K 30K 3000K 35K 3500K 40K 4000K 18K30K Dim to Warm (23W-1430 Lm) | ST Standard (Default) NB Narrow Beam * *(For 15D and 24D beam spread lens.) Not applicable for 18K30K color temp | 90C 90CRI (Default) 95C 95CRI* | 3G 3rd Gen | 60D 60° (Default) 45D 45° 38D 38° 24D 24° 15D 15° | ST3: For wattages range 14 and 23W ST3L For wattages below 14W ST3H For wattages above 23W LPH (4) Lutron Hi-Lume 1%, Fade-to-Black EcoSystem, 120-277V LPL (4) Lutron Hi-Lume 0.1% Premier, Fade-to-Black EcoSystem, 120-277V DMX DALI For wattages below 12W Note: All ST3 drivers Tri Mode and dims to 1%: 0-10V (120-277V) Triac/ELV (120V only) | AT Airtight (Default) CP ChicagoPlenum |
| Accessories | | Optional | | Nailer Bars | | Trim Adapter | | |

CL Clear Lens
LI Linear Lens
PR Prismatic Lens
SA Sanded Lens
SO Softening Lens
MB Micro Louver Black
MA Micro Louver Aluminum

Note: 5/8" sheetrock can accept 1 accessory, taller ceilings can accept 2. These are all optional accessories. A Solite Lens is automatically included with each fixture.

MI Micro Inverter *
CB C-Channel bars with butterfly mouting brackets for acoustical ceiling, Nailer bars included.

*Micro inverter requires access above ceiling, otherwise it must be installed remotely.

Note: Standard nailer bars are **not** to be used in ACT Ceilings.

HBAR Standard Nailer Bars
HBAR-V2 Thicker Nailer Bars (for use in ACT ceilings)

COLR*
For use with Series AS (trimmed) trims
ADPT-SQ-UNV-3G
For use with series BS (trimless) square trims in sheetrock
ADPT-SQ-HARD-3G
For use with series BS (trimless) square trims in wood(mill-work)/stone ceilings
ADPT-RD-UNV-3G
For use with series BS (trimless) round trims in sheetrock
ADPT-RD-HARD-3G
For use with series BS (trimless) round trims in wood (mill-work)/stone ceilings

* Consult factory for use in ceiling thicker than 1"

Note: 1. 12°, 24° optics have a unique LED module not available for field changable. 12°, 24° optics are not available for Dim to Warm.
 2. Not available for 1/2" sheetrock, 5/8" sheetrock can accept 1 accessory, taller ceilings can accept 2.
 3. Micro inverter requires access above ceiling, otherwise it must be installed remotely.
 4. This fixture comes with a solite lens attached to the trim.

TRIM ORDERING CODE SELF FLANGED

Example: **NVTN-3-TRIM-AS-SQ-WH-WH-ADPT-RD-UNV-3G**

| Product | Type | Outer Finish | Inner Finish |
|---|--|---|--|
| NVTN-3-TRIM-AS | | | |
| NVTN-3-TRIM-AS Self flanged trims Note: Solite Lens included on trim | SQ Shallow Square* RD Shallow Round *Uses Square lens cone | WH White BK Black XX Custom Powder Coating (Consult factory for colors) | WH White BK Black SH Shower Trim (for damp locations) XX Custom Powder Coating (Consult factory for colors) |

TRIM ORDERING CODE TRIMLESS

Example: **NVTN-3-TRIM-BS-SQ-WH-ADPT-SQ-UNV-3G**

| Product | Type | Inner Finish | Shower |
|---|--|---|--|
| NVTN-3-TRIM-BS Trimless trims Note: Solite Lens included on trim | SQ Shallow Square* RD Shallow Round *Uses Square lens cone | WH White BK Black XX Custom Powder Coating (Consult factory for colors) | (leave blank) For Dry/Damp Locations SH Shower Trim (for wet locations) |

TRIM COMPATIBILITY



Requires round sheetrock cutout:
4.0625" Diameter



Requires square sheetrock cutout:
4.125"x4.125"

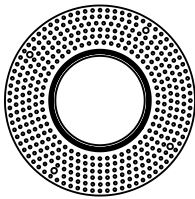

Round Adapter

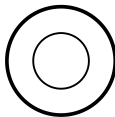

Series BS
Round Trim

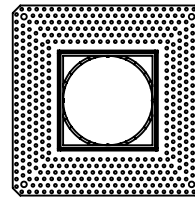

Square Adapter

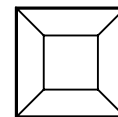

Series BS
Square Trim

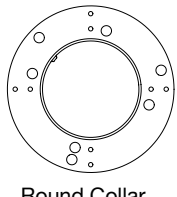

Round Collar

Note: Collars are pre installed on the fixture.

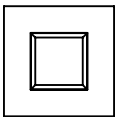

Series A
Square Trim

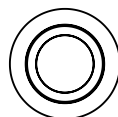

Series A
Round Trim

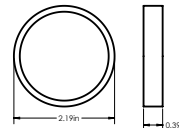

Round Lens Cone

Note: Round lens cone is pre installed on every fixture. Square lens cone is provided, and can be replaced in the field in needed.

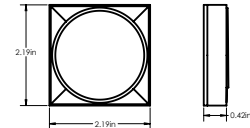

Square Lens Cone

TRIM OPTIONS

NVTN-3-TRIM-AS

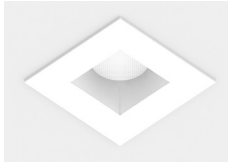

NVTN-3-TRIM-AS-SQ-WH-WH

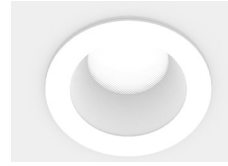
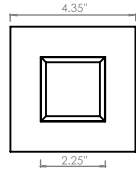

NVTN-3-TRIM-AS-RD-WH-WH

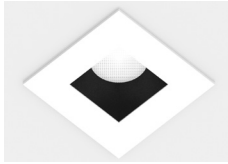
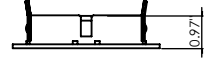
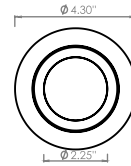

NVTN-3-TRIM-AS-SQ-WH-BK

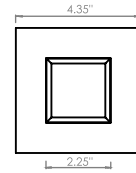

NVTN-3-TRIM-AS-RD-WH-BK

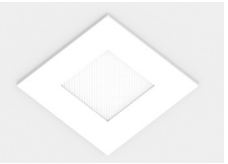
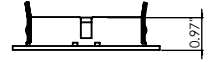
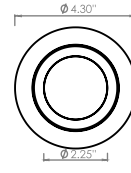

NVTN-3-TRIM-AS-SQ-WH-SH

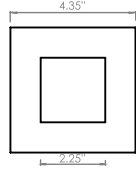

NVTN-3-TRIM-AS-RD-WH-SH

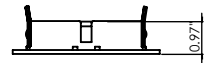
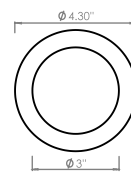

NVTN-3-TRIM-BS



NVTN-3-TRIM-BS-SQ-WH

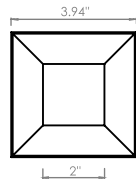

NVTN-3-TRIM-BS-RD-WH

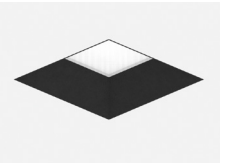
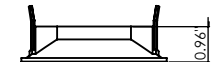
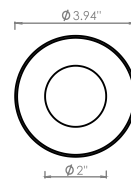

NVTN-3-TRIM-BS-SQ-BK

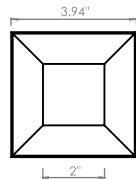

NVTN-3-TRIM-BS-RD-BK

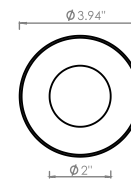

TRIM ADAPTER

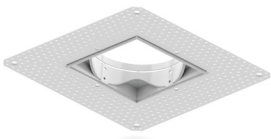

NVTN-ADPT-SQ-UNV-3G*

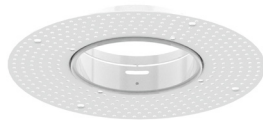

NVTN-ADPT-RD-UNV-3G*

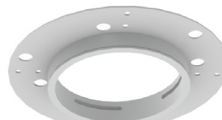

NVTN-3-COLR

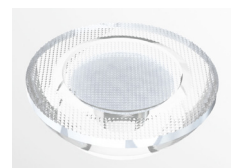

XXD Beam Spread Lens

OPTICS ACCESSORY



CL Clear Lens

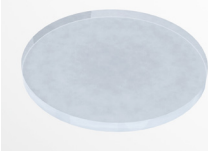

SO Softening Lens

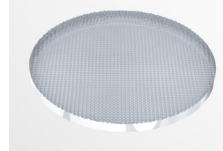

PR Prismatic Lens



SA Sanded Lens

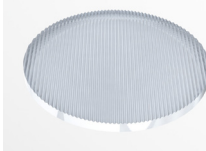

LI Linear Lens

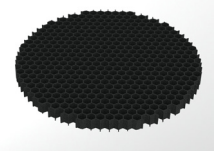

MB/MA Micro-louver
(Black or Aluminum)

ASSEMBLED VIEW

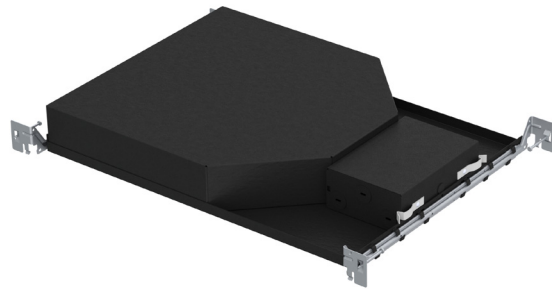
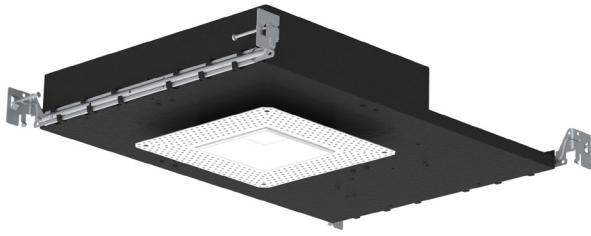

Nailer bars

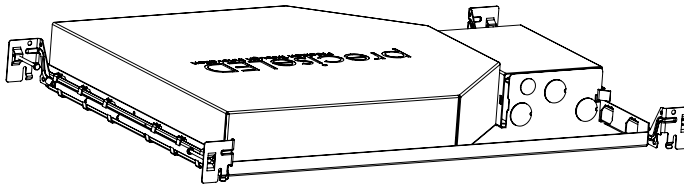

CB Bracket

(C-Channel bars with butterfly mounting brackets for acoustical ceiling)

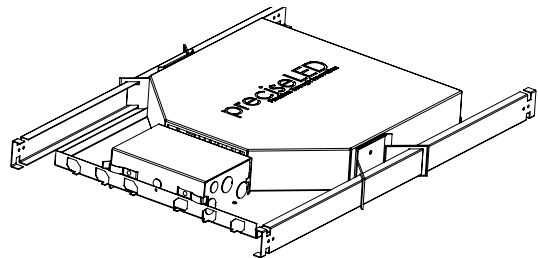

Note: Able to move fixture along C-Channel for position adjustments

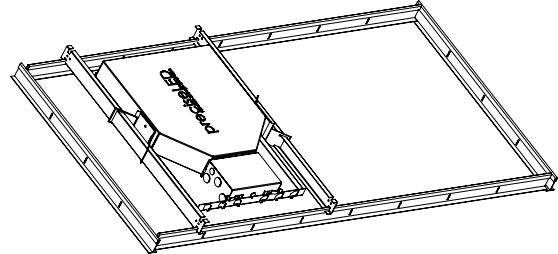

■ SPECIFICATIONS

LED SYSTEM

- LED ENGINE: CREE: 2700K, 3000K, 3500K, 4000K, LUXTECH: 18K30K dim-to-warm, field-replaceable LED module solderless replacement process
- LUMENS/WATTS: 10W, 15W, 23W, 30W See lumen output chart on Page 1
- CRI: Minimum 90 color rendering index with an option of 95 CRI
- COLOR CONSISTENCY: 2-step binning LEDs

OPTICS

Multiple Beam Spread Options Available

ELECTRICAL

- DRIVERS:
 - Standard ST3 Series driver is Tri Mode and dims to 1%: for 0-10V (120-277V) and for Triac/ELV (120V only).
 - LUTRON DRIVER LPH : Hi-lume EcoSystem with Soft-on, Fade-to-Black LED Driver, dim down to 1% and fade smoothly between 0%-1%.
 - LUTRON DRIVER LPL : Hi-lume Premier EcoSystem with Soft-on, Fade-to-Black LED Driver, dim down to 0.1% and fade smoothly between 0%-0.1%
 - DMX/Dali driver(120-277V)
- FEED: Standard 18-gauge/5 conductor single circuit feed. Push-in quick connectors allow ease of driver replacement.
- EMERGENCY: Remote emergency battery pack provide backup power for 90 minutes. Remote emergency test switch included.

MOUNTING

Residential grade nailer bars included with housing, fitted to short side of IC housing, extend 14" to 25" to fit different joist spacing. C-channel available with butterfly bracket for acoustical ceiling installation. Accommodates to 1/2" , 5/8", 3/4", 1.0" ceiling thickness in drywall, millwork and acoustical ceiling types.

CONSTRUCTION

- HOUSING: Heavy gauge cold rolled steel with through wire J-box
- HEAT SINK: Precision-cut extruded aluminum heat sink.
- HEAT PIPE: Six vacuum-sealed copper tubes transfer heat away from the LED to heat sink with 29 aluminum cooling fins
- TRIM: Die-cast aluminum with Solite glass
- LENS COVER: Use round lens cover for both round/square trims
- TRIM ADAPTER: Die-cast aluminum, spackle flanges are use in sheetrock/mud-in ceiling applications. Trim collar are available for flanged trim.

FINISH

- HOUSING: Standard powder-coated matte black.
- TRIM: White, Black, Consult factory for custom powder coating finish.

LISTING/WARRANTY

- APPROVALS: UL/C-UL listed, Suitable for dry/damp/wet location. Airtight rated, meets ASTM E283 standards. Chicago Plenum housing available. IC Rated.
- WARRANTY: 5 Year Limited Warranty, Ambient temperatures at fixture location should not exceed 40° C during normal operation.
- LED LIFE > 61,000 hours at 70% lumen maintenance (L70)
- WEIGHT: 12.6lbs
- Patent No. 10174891
- Can be used to comply with Title 24/JA8 requirements (using ST3 driver and white trim with no accessories. For full list of compatible models please contact factory)



DIMMER COMPATIBILITY CHART

| Standard Driver ST3 | | | | | |
|---------------------|---------|----------------------|---------------|-------------------------|--------------|
| Dimmer Manufacturer | Product | Part Number | Dimming Range | Qty Fixture Per Control | Dimming Type |
| 120V/277V | | | | | |
| Lutron | Diva | DVTV*/DVSTV/ DVSCSTV | 1%-100% | 1-14 | 0-10 V |
| Lutron | Nova | NFTV* | 1%-100% | 1-14 | 0-10 V |
| 120V Only | | | | | |
| Lutron | Skylark | CT-103P(MLV) | 1%-100% | 1-26 | ELV |
| Lutron | Skylark | SELV-303P/SELV-300P | 1%-100% | 1-13 | ELV |

* NVTV/NFTV "DIMMING ONLY" or "USE WITH PowerPack for Dimming+on/off"

WIRING DIAGRAM

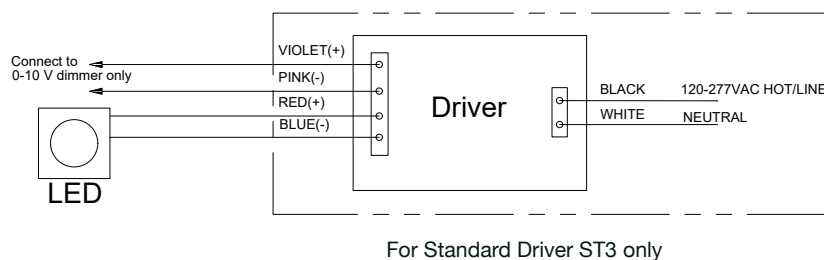

Note: Cap off violet and pink wires individually if 0-10 V dimming is not desired.

For Standard Driver ST3 only